

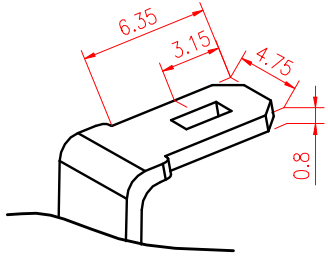

# Ritar Power International Group

 <p>F1 Terminal</p>	 <p>F2 Terminal</p>	 <p>F3 Terminal</p>	 <p>F4 Terminal</p>	 <p>F5 Terminal</p>	 <p>F6 Terminal</p>
 <p>F7 Terminal</p>	 <p>F8 Terminal</p>	 <p>F9 Terminal</p>	 <p>F10 Terminal</p>	 <p>F11 Terminal</p>	 <p>F12 Terminal</p>
 <p>F13 Terminal</p>	 <p>F14 Terminal</p>	 <p>F15 Terminal</p>	 <p>F16 Terminal</p>	 <p>E17 Terminal</p>	 <p>F18 Terminal</p>
 <p>F19 Terminal</p>	 <p>F20 Terminal</p>	 <p>NEG POS F22 Terminal</p>		 <p>F315 Terminal</p>	
 <p>L0 Terminal</p>	 <p>L1 Terminal</p>	 <p>L2 Terminal</p>	 <p>NEG POS L3 Terminal</p>		
 <p>NEG L4 Terminal</p>	 <p>POS L5 Terminal</p>	 <p>L6 Terminal</p>	 <p>L7 Terminal</p>		
 <p>UL 1007 18AWG T1 Terminal</p>	 <p>UL 1007 18AWG T2 Terminal</p>	 <p>UL 1007 20AWG T9 Terminal</p>	 <p>UL 1007 20AWG T11 Terminal</p>	 <p>T23 Terminal</p>	 <p>T24 Terminal</p>
 <p>T25 Terminal</p>	 <p>T26 Terminal</p>	 <p>T27 Terminal</p>	 <p>T28 Terminal</p>	 <p>T30 Terminal</p>	 <p>UL 1007 22AWG T31 Terminal</p>

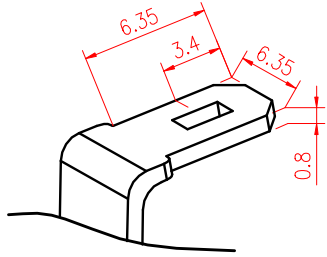
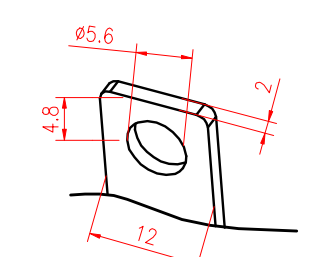
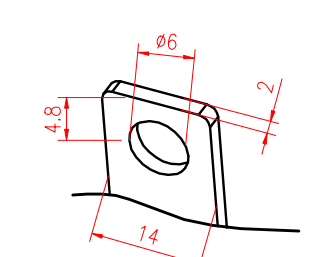
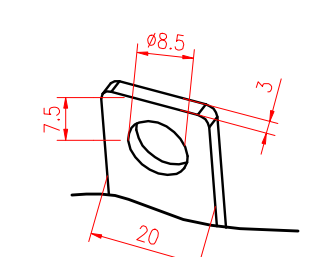
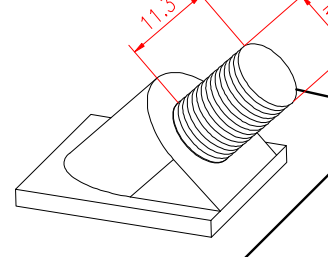
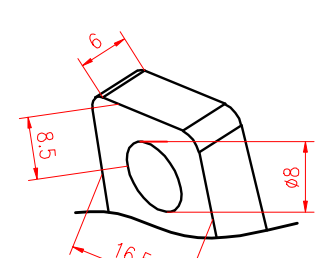
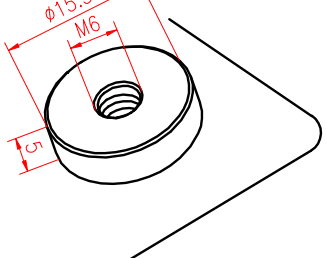
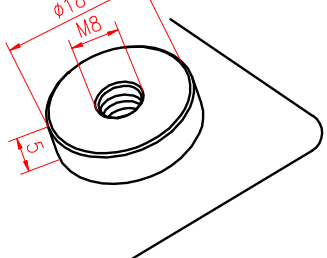
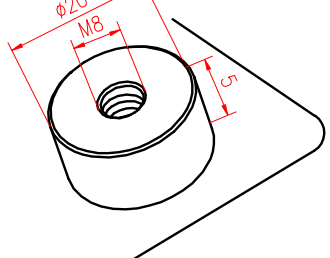
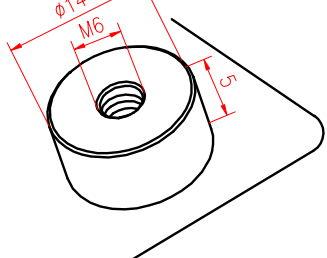
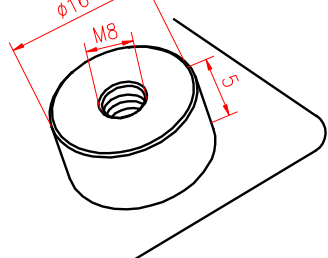
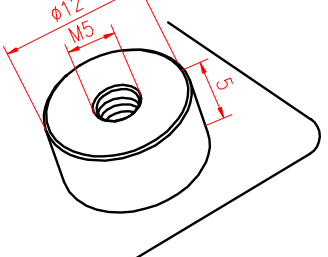
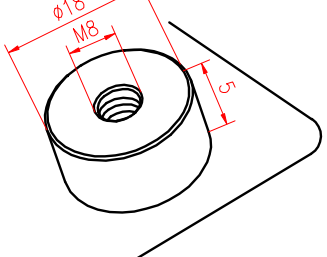
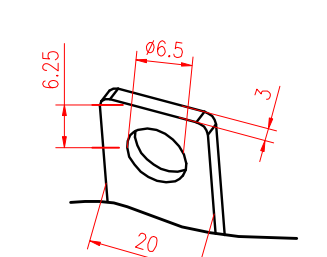
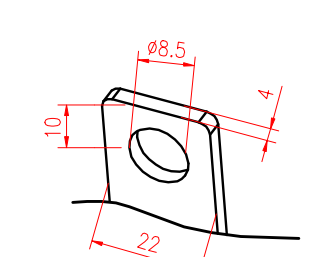
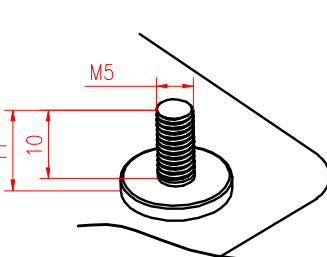
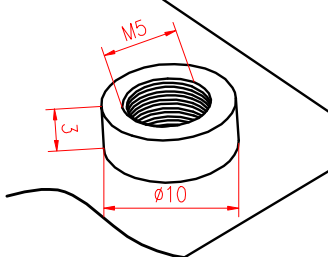
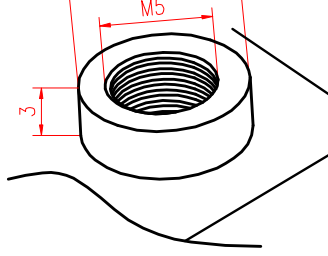
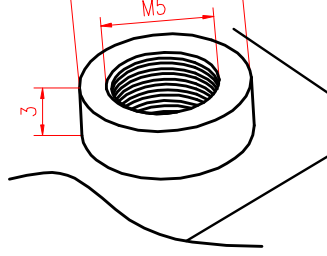
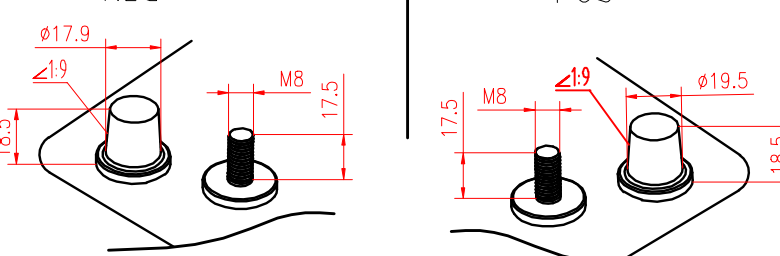
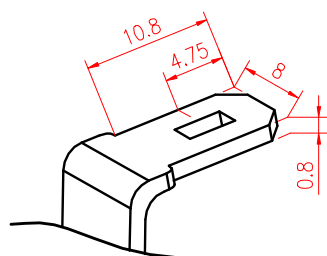
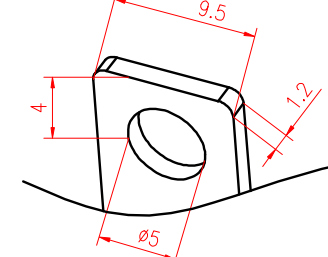
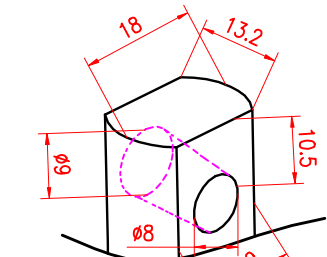
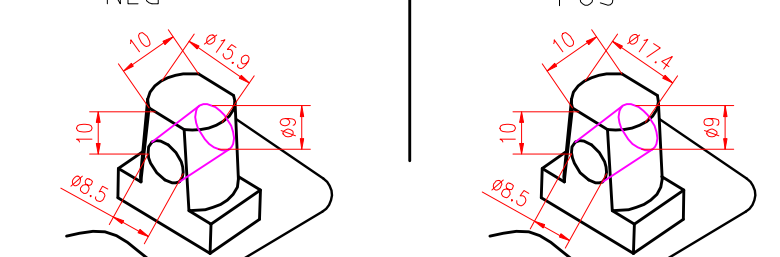
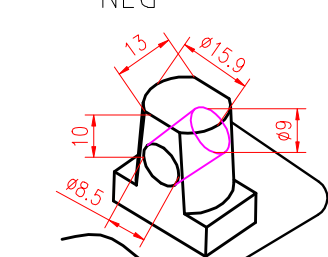
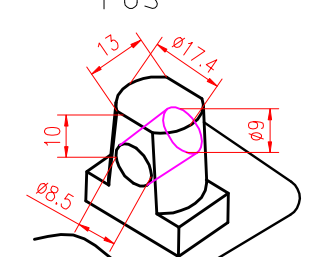
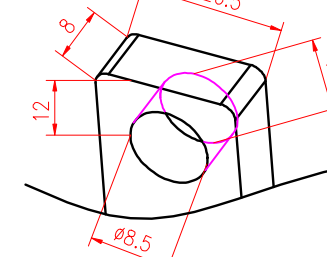
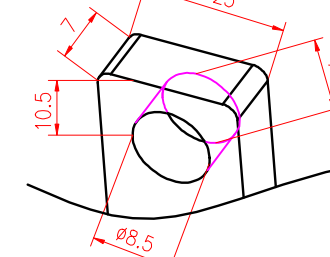
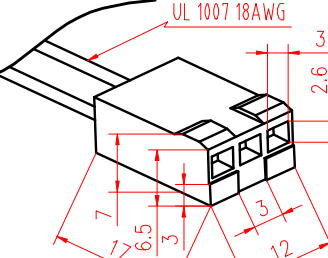
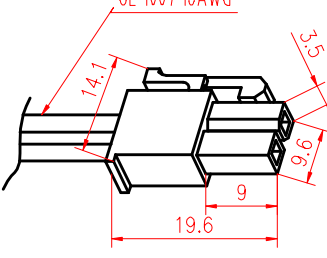
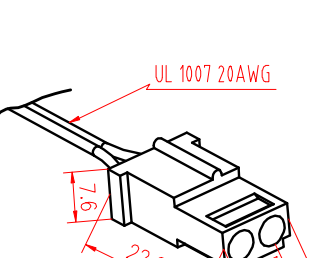
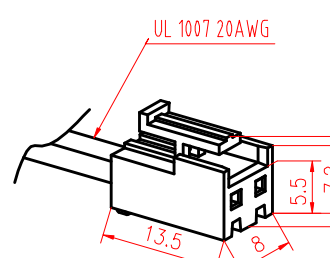
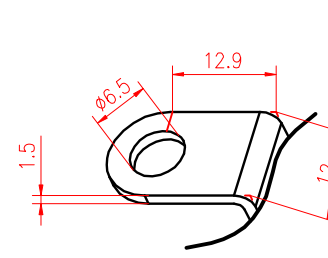
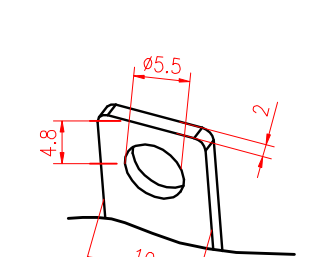
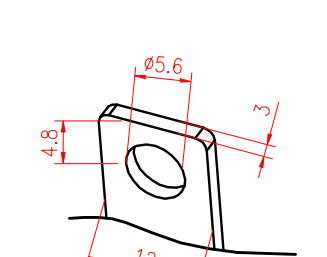
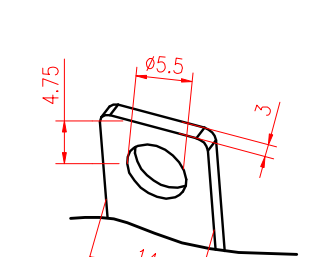
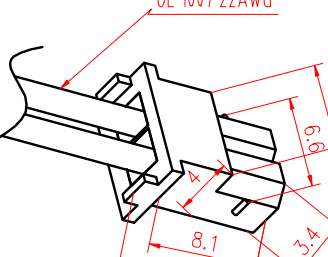

# Ritar Power International Group

--





Ritar Power International Group

端子套 参数	H1	H2	H3	L1	∅1	∅2	∅3	∅4	∅5	∅6	∅7
AP50	7	21	3	32	38	4.5	22	18	24	35	45
AP100	6.5	21	3	26	30.5	4.5	17.5	13.5	19.5	27	37
AP200	5	17.5	3	24.5	25.5	4	16	12	18.5	22.5	31
AP300	4	17.5	2	20.5	18.5	4	12.5	10	14.5	16	22.5

端子套 参数	H1	H2	H3	L1	L2	∅1	∅2
AP400	6	17	9	43	25	25	21
AP500	6	11	6	32	20	20	16

端子套 参数	H1	H2	L1	L2	∅1	∅2
AP600	17	6	25	25.5	25.5	22
AP700	14	6	20	19	19	16



RT12200 Article plastic

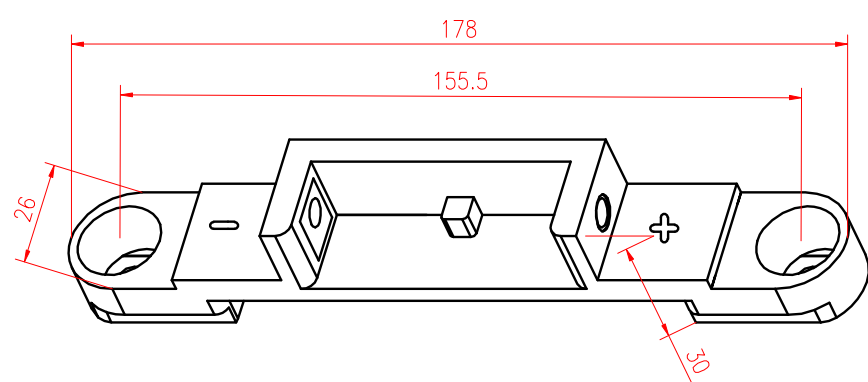

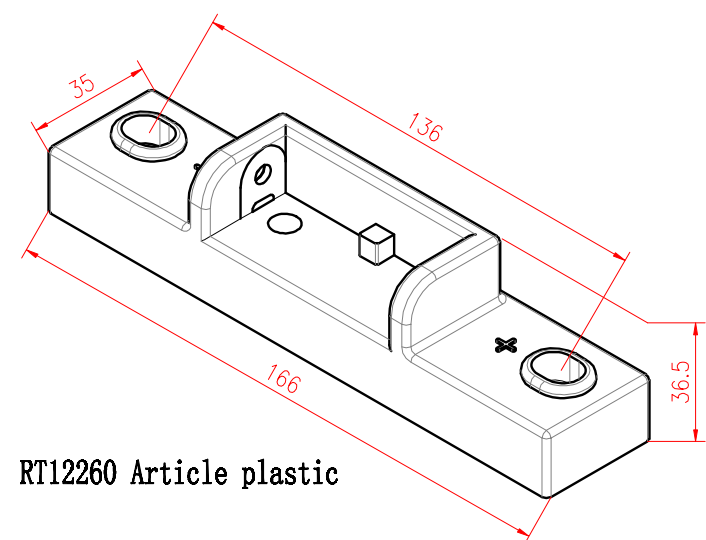
RT12260 Article plastic

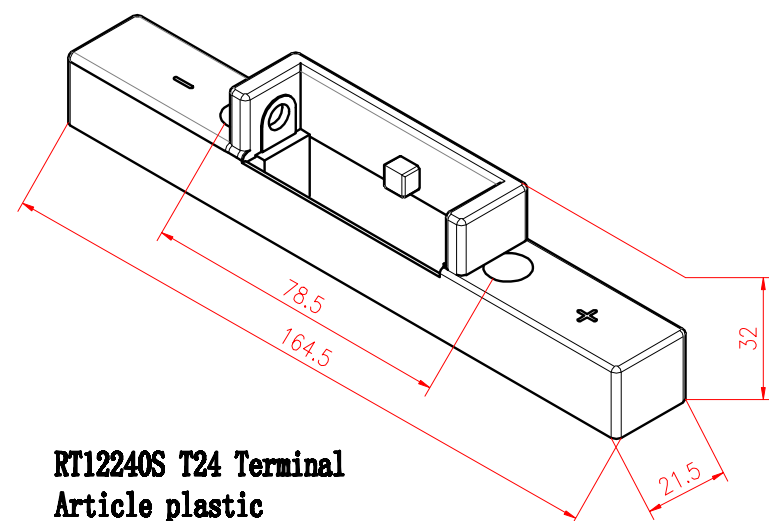

RT12240S T24 Terminal Article plastic

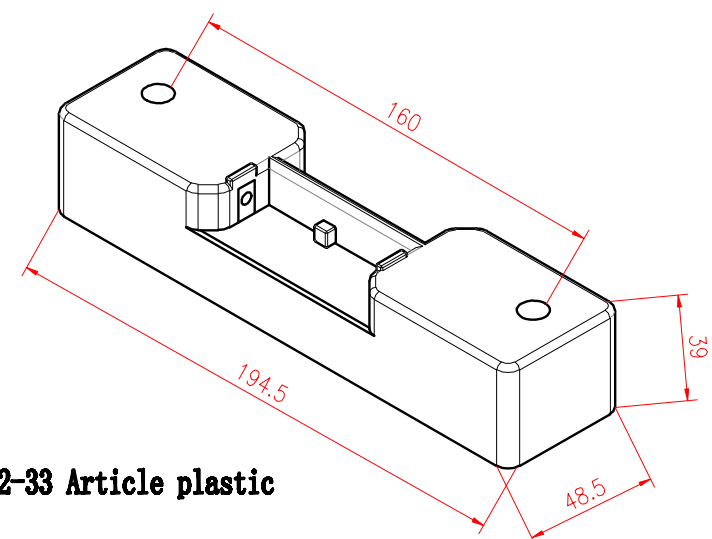

RA12-33 Article plastic